

**TORO**

Count on it.

# TMC-424

TORO MODULAR CONTROLLER  
4 TO 24 STATIONS

English

Español

Frèngçais





## User's Guide

## Introduction

Thank you for purchasing a Toro TMC-424 modular series controller.

The versatile TMC-424 is easily expanded from 4 to 24 stations with plug-in 4- and 8-station output modules. It's flexible modular design, coupled with an intuitive, full-feature timing mechanism, makes the TMC-424 controller an ideal choice for residential, commercial and sports field irrigation systems.

The plug-in control modules are available in six configurations as shown in the chart below.

Model Number	Color Code	Station Count	Surge Level	Surge Icon	Flow Monitor	Flow Monitor Icon	Master Valve Control
TSM-4	Gray	4	Standard	⚡	No	—	No
TSM-8	Gray	8	Standard	⚡	No	—	No
TSM-4H	Beige	4	High	⚡⚡	No	—	No
TSM-8H	Beige	8	High	⚡⚡	No	—	No
TSM-4F	Blue	4	High	⚡⚡	Yes		Yes
TSM-8F	Blue	8	High	⚡⚡	Yes		Yes

The modules can be mixed and matched in any combination and are true “Plug-&-Play” compliant. Just snap a module into any open module bay and it is instantly recognized by the timing module.

### TMC-424 Features Include:

- Advanced hybrid timing module featuring an intuitive, easy-to-use interface
- Non-volatile memory retains program information for years without battery
- Four independent watering programs
- 16 program start times allotted to programs in any combination of 0–16
- Watering days scheduled by Calendar, Interval or Odd/Even days
- 365-day calendar with leap year correction
- Watering exclusion days allowed in Interval or Odd/Even watering day schedule
- Station run time adjustable from 1 second to 8 hours
- Water Budgeting (global run time adjust) by program from 0–200%
- Rain delay to postpone automatic operation from 1–14 days
- Master valve/pump start control selectable by program
- Flow monitoring from multiple sources—up to three sensors simultaneously
- Dedicated master valve control on flow monitoring modules
- Manual operations by program and individual station
- Built-in provision for Toro Rain Sensor and EZ-Remote control accessories.

# Table of Contents

<b>Controller Components</b>	2
<b>Getting Started</b>	5
<b>Programming the Controller</b>	5
Set Current Time and Date	6
Select the Program	6
Set Station Run Time	6
Set Program Start Time	7
Set Watering Day Schedule	7
<b>Special Functions</b>	9
Well Recovery/Station Delay Time	9
Program Stacking/Sequential Operation	10
Program Memory Erase	10
Pump Start/Master Valve Operation by Program	10
Pump Start /Master Valve Operation by Station	11
International Display Languages	11
Clock Time Display Format	11
Station Run Time Display Format	11
Hand-held Remote Operation	11
<b>Manual Operations</b>	12
Manual Operations by Station	12
Manual Operations by Program	13
<b>Flow Sensor Operation</b>	14
<b>Rain Sensor Timed Bypass Function</b>	16
<b>Water Budget Function</b>	16
<b>Valve Test Function</b>	17
<b>Program Review Function</b>	17
<b>Rain Delay Function</b>	18
<b>Installation Instructions</b>	19
<b>Appendix</b>	25
<b>Troubleshooting</b>	27
<b>Specifications</b>	28
<b>The Toro Promise — Limited Five-year Warranty</b>	29
<b>FCC Compliance Information</b>	30

## Controller Components

The following brief descriptions of the controller components and display elements are provided for general overview. Each of these items will be explained in further detail in the appropriate section of this guide.

### 1- Service Reset Button

Facilitates controller CPU initialization (for service only).

### 2- 9-V battery compartment

### 3- 9-V battery clip

Battery required for Armchair Programming. Keep attached to TM when battery is not used.

### 4- Program Switch

A four-position slide switch used to select program A, B, C and D for set up, review and manual operations.

### 5- Digital Display

- a- Station run time icon.
- b- Start time icon.
- c- Program identifiers.
- d- Prompt displayed with Interval schedule length
- e- Flow sensor icon indicates bay location of flow module.
- f- % symbol is displayed when water budget function is applied.
- g- Water drop icon indicates water On and Off (slash).
- h- Prompt displayed to indicate current position in an Interval watering day schedule.
- i- Expansion module bay identifier (I, II and III, left to right).
- j- Expansion module station identification numbers.

### 6- Navigation Buttons



Left and right arrow buttons to index through display menu items for each dial setting.

Up and down arrow buttons change time/percentage values and select Yes/No options.

### 7- Function Dial

Turns in either direction to select the following operating, control and programming functions:

**RUN**  – Home dial position for automatic controller operations.

**SET TIME/DAY**   – Set the clock time, day and date.



**SET STATION RUN TIMES**  – Set the run time for each station.

**START TIMES**  – Set the program start times.

**CALENDAR DAYS**  – Set program watering day schedule by days of the week.

**ODD/EVEN**  – Set program watering day schedule by Odd or Even numbered days.

**DAY INTERVAL**  – Set program watering day schedule by interval period from 1 to 31 days.

**SPECIAL FUNCTIONS**   – Provides menu of options for set up, control and timing features. (See page 9.)

**MANUAL STATIONS**  – Enables individual stations to be operated manually.

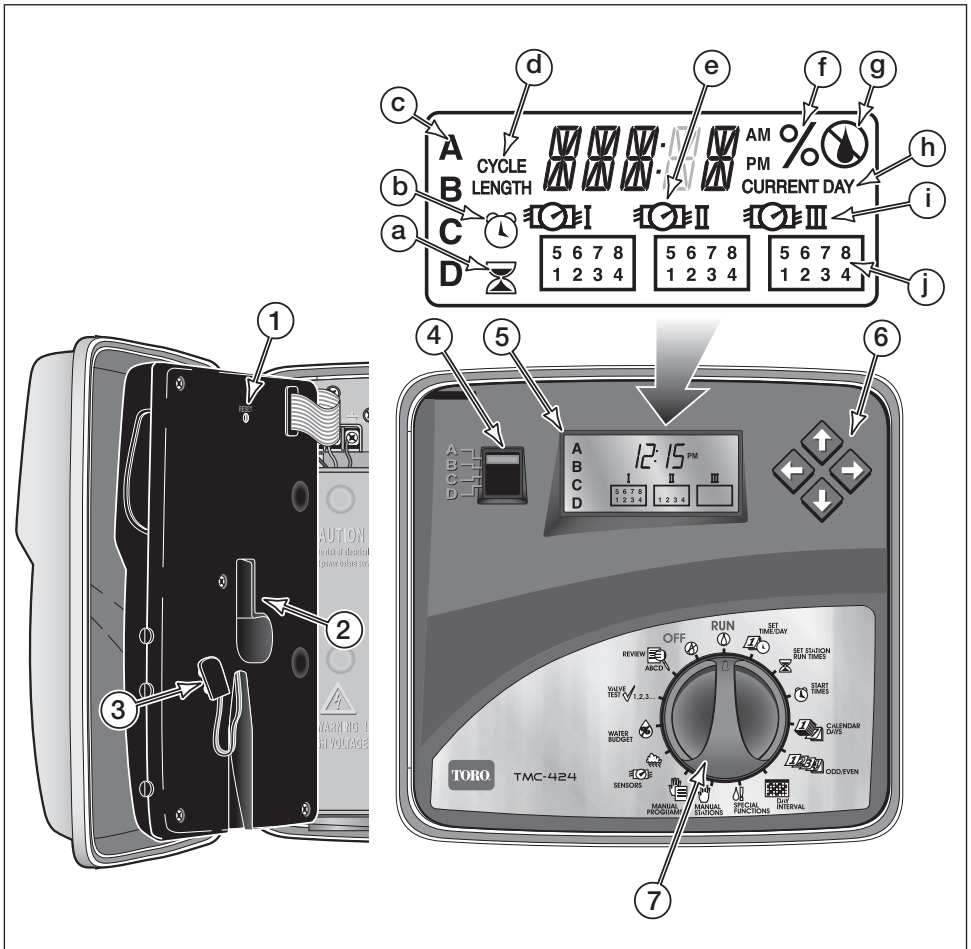



**MANUAL PROGRAMS**  – Enables individual watering programs to be manually started.

**SENSORS**  – Enables flow monitoring parameters to be selected and set for each station.

**WATER BUDGET**  – Enables the station run time of all stations in a program to be simultaneously increased to 200% or decreased to 0% (Off) in 10% increments.

**VALVE TEST**  – Enables all stations to be operated in sequence for a selected temporary run time from 30 seconds to 10 minutes.

**REVIEW**  – Provides a summary of all watering program settings including: start times, station run times and water budget.

**OFF**  – Shuts off and prevents all automatic and manual watering operations.

## Controller Components

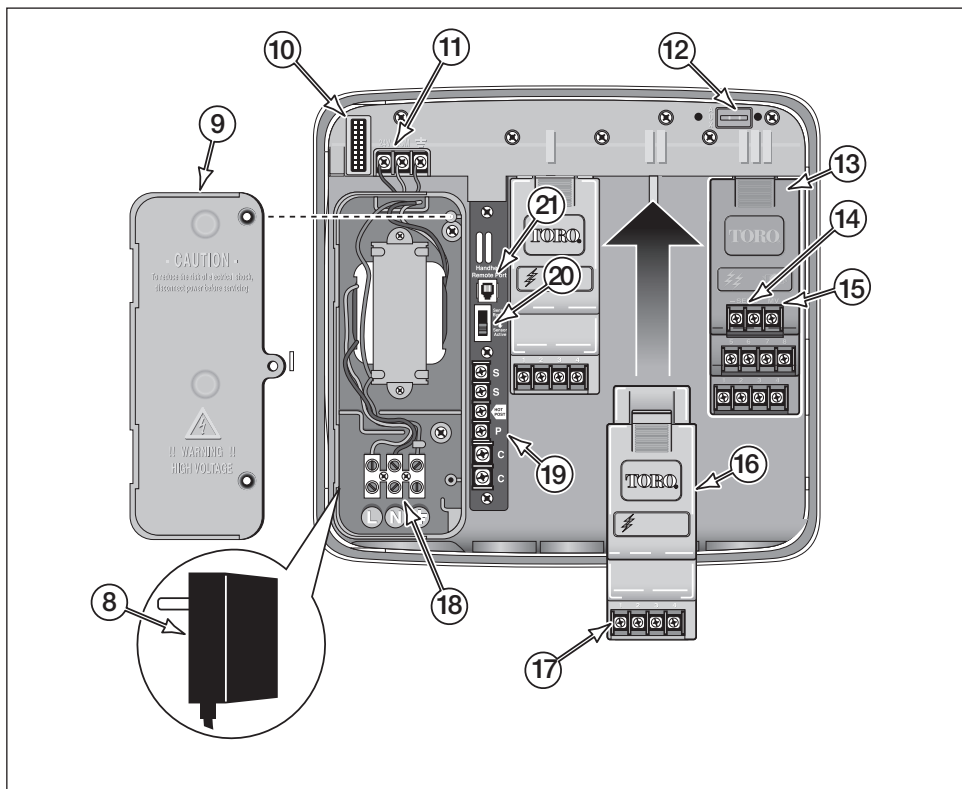

**8- Plug-in transformer**  
(indoor models only)

**9- Power supply compartment cover** (outdoor models only)

**10- Control panel cable receptacle**

**11- Plug-in transformer connection terminals** (indoor models only)

**12- Auxiliary port** (not enabled)

**13- Flow Sensor module** (8-station, high-surge model shown)

**14- Flow sensor connection terminals**

**15- Master valve connection terminal (flow module)**

**16- Standard module** (4-station, standard-surge model shown)

**17- Valve connection terminals**

**18- Power source connection terminals** (outdoor models only)

**19- Wire connection terminals for:**

- Field Common(s)
- Pump/Master Valve
- Hot Post
- Rain Sensor

**20- Rain sensor bypass switch**

**21- EZ-Remote modular plug port**

## Getting Started

The unique design of TMC-424 Series takes "modularity" to the next level. The modular components of this series controller are:

- Color-coded 4-and 8- station Expansion Modules for easy identification of model options.
- Modular internal power supply to adapt to your customer or site job needs.
- Modular timing mechanism is easily removed from the cabinet for remote "Armchair Programming."

Armchair Programming enables you to remove the timing module from the cabinet after AC power has been initially applied and modules recognized. With the control knob in the OFF position, swing the module out and connect a 9V battery. Simply unplug the ribbon cable and push down on the top module hinge to release. Now, you can program the controller, review your watering schedules and have the system ready to run automatically upon completion of the installation.

### What is a watering program?

In basic terms, a watering program is a small set of instructions that tells the controller which days will be active for watering, when to start a watering cycle, and how long each station will operate during the cycle. The TMC-424 series has four independent watering programs identified as **A**, **B**, **C**, and **D**.

Separate programs are usually used to group stations with similar landscape or watering attributes or to provide a way of segmenting specific site conditions, such as north-facing slopes or shaded areas. As you can see, the availability of four programs allows you to have unique watering programs for your varied landscape needs. Watering programs can be operated in sequence or simultaneously as you choose. This feature enables more watering to be completed within the prime watering time, which is generally between Midnight and 6:00 a.m.

### What is a program watering cycle?

When a program start time is selected, that time becomes the beginning of an automatic watering cycle. A watering cycle operates each station with an assigned run time duration in the program, one by one, in numeric sequence from the lowest to the highest station number.





The TMC-424 provides up to 16 watering cycle start time slots that can be allocated to programs A, B, C and D in any combination. For example, Program A could have 10 start times; Program B four start times; Program C two start times and Program D no start times. Any combination up to 16 start times is permitted.

**Note:** A Watering Schedule Form is provided for your convenience. Use this form to plan and record your automatic watering information. Keep the card handy for reference by attaching it inside the cabinet cover.

## Programming the Controller

**Note:** English display prompts and 12-hour (a.m./p.m.) time format are default control module interface settings. To select Spanish, French, Italian or German as the display language, and/or a 24-hour time format, refer to the Special Functions information page 9.

### Set Current Time and Date

1. Turn the Function Dial clockwise to the **Set Time/Day**  position. The hour digits will begin flashing.
2. Adjust the display by pressing the  or  buttons.  
**Note:** Hold either button down for rapid advance.
3. Press the  button to advance to the next field.
4. Repeat steps 2 and 3 to set the current minutes, year, month and day (current weekday will be temporarily shown).
5. Return the Function Dial to the **RUN**  position when finished.

### Select the Program





To simplify the programming process, the following procedure is provided to set up one watering program at a time.

**Note:** If the controller has been previously programmed, the user-defined memory can be quickly erased if desired. Refer to “Program Memory Erase” on page 10.

1. Set the Program Switch to select Program **A, B, C, or D**.





### Set Station Run Time

**Note:** A station is assigned to the selected program when it is given a run time duration. The station can have only one run time assigned per program, but can have a different run time assigned in each remaining program. The run time is set in minutes and hours by default but can be set in seconds, minutes and hours. See “Station Run Time Display Format” on page 11 to select this option.

1. Turn the Function Dial to the **Set Station Run Times**  position.
2. Press the  or  buttons to select the station number.  
**Note:** Each station number (1 to 4 or 1 to 8) will be displayed in the box corresponding to the module installed in each bay (I, II and III).
3. Press the  or  buttons to adjust the station run time from Off (– – –) to 8 hours (in 1-minute increments) or 1 to 59 seconds (if the option is selected).  
**Note:** Hold either button down for rapid advance.
4. Repeat steps 2 and 3 for all stations to be assigned to the selected program.

## Set Program Start Time

**Note:**The TMC-424 provides a total of 16 watering cycle start time slots to be allocated among the four programs in any combination.

1. Turn the Function Dial to the **Set Start Times**  position.
2. Press the  or  buttons to select a start time slot number from 01 to 16.  
**Note:** If there are no start times available for the program, **NONE** will appear in the display.
3. Press the  or  buttons to select a start time. (Note a.m./p.m. designation.)  
**Note:** Off (-- --) is located between 11:59/12:00 and 5:59/6:00 display times.
4. Repeat steps 2 and 3 to assign additional start times.  
**Note:** The TMC-424 will operate one watering cycle in a program at a time. If another start time occurs while a watering cycle is in progress, the start time will be postponed until the previous cycle is finished (known as Stacking). If the watering cycle extends past midnight into the next day, the watering cycle will continue operating until finished. However, if a watering cycle start has been postponed until after midnight into a day that is not scheduled to water, the cycle will be canceled.

## Set Watering Day Schedule

The TMC-424 series offers three watering day schedule formats. Each program can have any one of the following schedule formats:

**Calendar Days** – Use this type of schedule to select specific days of the week. The days are displayed in abbreviations. For example, Sunday = sun, Monday = mon, etc.







**Odd/Even** – To select every odd or even numbered calendar day, use this option. Since the 31st and the 1st are consecutive odd numbered days, the 31st will never be active. There is also an automatic over-ride for February 29th of a leap year.

**Day Interval** – Scheduling watering by Day Interval enables a specific number of days between watering to be selected. For example, selecting a 1-day Interval schedules watering for every day. A 2-day interval schedules watering for every other day. A 31-day interval is the maximum interval frequency, and provides watering once every 31 days. Since the interval schedule is not tied to specific days of the week, you will also need to determine when the interval schedule will start by selecting the current day within the Interval.







- **Day Exclusion** – When using an **Odd/Even** or **Day Interval** watering day schedule, watering will not always occur on the same days each week. To prevent watering on a specific days, for example, on Saturday because it is generally the day for yard maintenance, Saturday can be excluded from the schedule.

**Note:** Each program can only have one assigned watering schedule format. If either an Interval or Odd/Even schedule is currently set, it must be turned off first to enable another format to be selected.



### To Set Calendar Days:

1. Turn the Function Dial to the **Calendar Days**  position.
2. Sunday will be displayed and selected to water indicated by the water  icon. To remove the day from the schedule, press the  or  buttons to display the No Water  icon.
3. Press the  button to select the next day.
4. Repeat step 2 and 3 to schedule the remaining days of the week.







### To Set Odd or Even Days:

1. Turn the Function Dial to the **Odd/Even**  position.
3. Press the  or  buttons to select **ODD** or **EVEN**.
4. To exclude specific days from watering, press the  button to select the day.
5. To exclude the day from the schedule, the  or  buttons to display the No Water  icon.
6. Repeat steps 4 and 5 to exclude additional days. 1 to 7 days can be excluded.

### To Set Interval Days:

1. Turn the Function Dial to the **Interval Days**  position.
2. The current interval number (**01** to **31**) or Off (**--**) will be displayed. The Cycle Length prompt will be displayed.
3. Press the  or  buttons to select an Interval number.



**Note:** The Interval cycle length can be set from 01 (water every day) to 31 (water once every 31 days). The Interval cycle starts at 01 and increases by 1 digit each day. The watering day occurs when the selected Interval cycle length is reached. To specify when the first watering day will occur, the current day within the interval cycle is selected. For example, if a 04-day Interval is selected and you want watering to begin in one day, set 03 as the Current Day.

4. To select the current day in the Interval cycle, press the  button, then press the  or  buttons to select from 01 (up to the selected interval number). The Current Day prompt will be displayed.
5. To exclude specific days from watering, press the  button to select the day.
6. To exclude the day from the schedule, the  or  buttons to display the No Water  icon.
7. Repeat steps 5 and 6 to exclude additional days. 1 to 7 days can be excluded.

**STOP** – This concludes the basic program setup procedures. Repeat these procedures starting at “Select the Program” on page 6 for each additional program you wish use at this time.

## Special Functions

The following operating and control options enable you to tailor the TMC-424 user interface and operating characteristics to suit the specific needs of the landscape and irrigation system.





When the Function Dial is turned to the **Special Functions**  position, the options are accessed in the following order by pressing the  button:

- Set program well recovery/station dwell time
- Select program stacking or sequential operation
- Erase program memory
- Set Pump/Master Valve operation (by program)
- Set Pump/Master Valve operation (by station)
- Select alternate display language
- Select alternate clock time display format
- Enable station run time to be set in seconds increments
- Enable/disable hand-held remote control capability

**Note:** The Function dial can remain in the Special Functions position while making selections. When all options have been selected, turn the Function Dial to the the **RUN**  position.

### • Well Recovery/Station Delay Time

This feature enables a pause or dwell time to be inserted between operating stations during a watering cycle. This control option is generally used when irrigation water drawn from a well or reservoir exceeds the holding capacity and requires time to recover sufficiently between stations. The time delay is adjustable from Off --- (default) to 55 seconds in 5-second increments or 1 to 30 minutes in 1-minute increments.

1. Set the Program Switch to select program **A, B, C** or **D**.
2. Turn the Function Dial to the **Special Functions**  position.
3. Press the  button as needed to display **WR ---** (Well Recovery [Off]).
4. Press the  or  buttons to select the delay time.





**Note:** Time increments will change from seconds to minutes as the display passes 55 seconds. The letter “**M**” indicates time display in Minutes.

(continued)

### • Program Stacking/Sequential Operation



This feature enables you to change from operating watering programs in sequence (stacked), to operating two or three programs simultaneously.

**▲ CAUTION: Before disabling the stacking feature, ensure the hydraulic capacity of the irrigation system and the controller's maximum current draw will not be exceeded if multiple stations and master valve/pump start circuits operate concurrently. Refer to Table 2 on page 26 to review various combinations of output loads and acceptable applications.**

1. Turn the Function Dial to the **Special Functions**  position.
2. Press the  button as needed to display **1PROG** (one program).
3. Press the  or  buttons to select **2PROG** or **3PROG**.

### • Program Memory Erase

This feature allows each program to be erased independently from one another. Erasing a program will remove all user-defined attributes including run times, start times, well recovery delay time, water budget % change and pump/master valve enable/disable option.

1. Set the Program Switch to select program **A, B, C, or D**.
2. Turn the Function Dial to the **Special Functions**  position.
3. Press the  button as needed to display **ERASE**.
4. Press and hold the  button until **ERASE** stops flashing and **DONE** is displayed, then release.





**Note:** The memory will not be erased if the button is released before **DONE** is displayed.

### • Setting Master Valve/Pump Start Operation







The factory default for the Master Valve/Pump Start (MV/PS) is On for all programs and stations. The TMC-424 allows you to disable MV/PS operation by specific program(s) and specific station(s).

**Note:** The TMC-424 has one standard Master Valve/Pump Start (MV/PS) connection terminal. The flow-sensing expansion module also provides a MV/PS connection terminal which operates independently and is not affected by this Special Functions option. For detailed information regarding flow sensing, refer to "Flow Sensor Operation" on page 14.

### •• Pump Start/Master Valve Control by Program

1. Set the Program Switch to select program **A, B, C, or D**.
2. Turn the Function Dial to the **Special Functions**  position.
3. Press the  button as needed to display **MV[A] – Y** - (Master Valve [program A] – Yes).
4. Press the  or  buttons to select **MV[A] – N** (Master Valve [program A] – No).





## •• Master Valve/Pump Start Control by Station

1. Turn the Function Dial to the **Special Functions**  position.
2. Press the  button as needed to display **MVS – N** (Master Valve/Station – No).
3. Press the  or  buttons to select **MVS – Y** (Master Valve/Station – Yes).
4. Press the  button. Station 1 (in the first active bay) will begin flashing. To enable MV/PS operation for the (flashing) station number, press the  button (the number will remain on the display). To bypass the station, press the  button (the number will be removed). Continue this process until only the stations to have MV/PS operation enabled remain displayed.

## • Display Language Options





The TMC-424 displays word prompts in English (ENG) by default and offers four additional languages options as follows:

Spanish (ESP), French (FRA), Italian (ITA) and German (DEU)

1. Turn the Function Dial to the **Special Functions**  position.
2. Press the  button as needed to display **ENG** (or the current language).
3. Press the  or  buttons to select the desired language





## • Clock Time Display Format

This feature enables the clock time display to be changed from the default 12-hour (am./p.m.) format to the 24-hour clock format.

1. Turn the Function Dial to the **Special Functions**  position.
2. Press the  button as needed to display **12H** (12-hour clock format).
3. Press the  or  buttons to select **24H** (24-hour clock format).





## • Station Run Time Display Format

This feature enables the station run time to be available in seconds (1 to 59) as well as minutes and hours (1 minute to 8 hours in one-minute increments).



1. Turn the Function Dial to the **Special Functions**  position.
2. Press the  button as needed to display **SEC – N** (Seconds – No).
3. Press the  or  buttons to select **SEC – Y** (Seconds – Yes).

## • Hand-held Remote Operation

The TMC-424 is EZ-Remote control ready. By default, the controller is set to operate remotely. Use the following procedure to disable this function.

1. Turn the Function Dial to the **Special Functions**  position.
2. Press the  button as needed to display **HH – Y** (Hand Held – Yes).
3. Press the  or  buttons to select **HH –N** (Hand Held – No).

# Manual Operations





There are several methods by which the TMC-424 can be operated manually. A separate Function Dial position is provided for **Manual Stations**  operation and **Manual Programs**  operation.

## Manual Operations by Station

The TMC-424 offers two ways to manually activate individual stations. The first method, called "True Manual" enables an individual station to be simply turned on without a specified run time duration.

The second method called "Timed Manual" enables selected stations to be run with a selected (temporary) run time duration.









### • True Manual Operation

1. Turn the Function Dial to the **Manual Stations**  position.
2. Press the  button as needed to display the station number (flashing).
3. Press the  button to turn on the station. ON and the Water On  icon will be displayed.



**Note:** The station will run continuously until any button is pressed or the Function Dial is turned. Watering will terminate at midnight if left unattended.

 **IMPORTANT:** True Manual operation will override **all** flow-sensing limits.

### • Timed Manual Operation

1. Turn the Function Dial to the **Manual Stations**  position.
2. Press the  button as needed to display the station number (flashing).
3. Press the  button to turn on the station. ON and the Water On  icon will be displayed.
4. Press the  or  buttons to select a run time.
5. Repeat steps 2 – 4 to continue selecting stations and assigning run times.
6. When all stations to be operated are displayed, turn the Function Dial to the **RUN**  position. The operating station number and the Water On  icon will be flashing. The stations will operate one at a time in numeric sequence. The automatic mode will resume when the manual operation is finished.





**Note:** To turn off an active station and start the next station in sequence, press the  button. Manual operation will be terminated when the last station number displayed has completed it's run time or has been skipped.

To end the a manual operation at any time, turn the Function Dial to the **OFF**  position. Wait for OFF to stop flashing, then turn the dial to the **RUN**  position.



## Manual Operations by Program

This type of manual watering is also known as “Semi-automatic” operation. When a program is started manually, it runs through the watering cycle as if it had been started automatically. A single program can be selected and started or multiple programs can be selected to run in sequence.







### • Single Program Operation

1. Set the Program Switch to select program **A**, **B**, **C**, or **D**.
2. Turn the Function Dial to the **Manual Programs**  position. The selected program letter and MAN will be displayed.
3. Press the  button. The program identification letter will begin flashing and the Water On  icon will be displayed.
4. Turn the Function Dial to the **RUN**  position. The selected station numbers will be displayed. The operating station number and the Water On  icon will be flashing. The stations will operate one at a time (for their set run time) in numeric sequence. The automatic mode will resume when the manual operation is finished.



**Note:** To turn off an active station and start the next station in sequence, press the  button. Manual operation will be terminated when the last station number displayed has completed its run time or has been skipped.

**To terminate operation**, turn the Function Dial to the **OFF**  position. Wait for display to stop flashing, then return the dial to the **RUN**  position.

### • Multiple Program Operation

1. Set the Program Switch to select program **A**, **B**, **C**, or **D**.
2. Turn the Function Dial to the **Manual Programs**  position. The selected program letter and **MAN** will be displayed.
3. Press the  button to start the program watering cycle. The program identification letter will begin flashing and Water On  icon will be displayed.
4. Set the Program Switch to select another program **A**, **B**, **C**, or **D**.
5. Press the  button. The program letter will begin flashing and the previous program letter will remain on. The selected program will be placed in sequence.
6. Repeat steps 4 and 5 to sequence additional programs.
7. Turn the Function Dial to the **RUN**  position. The program letter currently operating will be displayed. The operating station number and the Water On  icon will be flashing. When the program has finished, the next program in sequence will start. The automatic mode will resume when the manual operation is finished.

**Note:** To manually turn off an active station and start the next station in sequence, press the  button. The program will end when the last station number displayed has completed its run time or has been skipped.

**To terminate operation**, turn the Function Dial to the **OFF**  position. Wait for the display to stop flashing, then return the dial to the **RUN**  position.

## Flow Sensor Operation

Flow monitoring is one of the best water resource management tools available in the irrigation industry today. With definable under-, over- and critical-flow limits set, broken lateral or mainline piping, stuck valves and damaged sprinklers can be quickly detected and bypassed automatically.

The TMC-424 accepts up to three Flow Sensor modules that enable it to read, store and compare flow rate data from individual flow meters.

If a combination of Flow Sensor and Standard modules are installed, all stations (including stations connected to standard modules) can be flow monitored. When a Flow sensor is installed, the flow meter  icon is displayed next to the corresponding bay number enabling you to:









- Automatically read and learn the flow rate of each station
- Measure flow as part of normal irrigation operation
- Set a lower, upper and critical-flow boundary range in 10% increments
- Immediately disable station and master valve operation if a flow rate exceeds the established limit.











After one minute of operation to allow system stabilization, a flow measurement is taken. If the flow rate exceeds the established boundaries, an alarm is triggered. The affected station is bypassed at this start time and retried at the next scheduled watering time. If the flow rate exceeds the critical limit, operation of the affected station is immediately bypassed.

















**Note:** The TMC-424 can run three programs (one station per program) simultaneously. When multiple stations operate simultaneously, the controller reads the average total flow of these stations. If the stations do not have the same flow range boundaries, the lowest % boundaries (narrowest range) will be used. If a critical-flow boundary is reached for any one of the stations, an alarm is triggered and the stations are bypassed.

### Flow Sensing Setup Procedure

**Note:** The TMC-424 is designed for use with Data Industrial 228 and 250 series flow sensors only. The **K** and **Offset** parameters for each flow sensor in these series are automatically factored when the flow sensor size is selected.



1. Turn the Function Dial to the **Sensors**  position.
2. Press the  button to display **DIA: 07**. This is the flow sensor size in inches. 07 = 0.75", 10 = 1.0", 15 = 1.5", 20 = 2", 30 = 3" and 40 = 4". The flow meter icon  indicates the module being addressed.
3. Press the  or  button to select the appropriate flow sensor size.
4. If more than one flow sensor is installed, repeat steps 2 and 3 as necessary.
5. Press the  button to display **MV:NC**. If a master valve is connected to the Flow Sensor Module, select the switch type: **NO** (Normally Open) or **NC** (Normally Closed).
6. Press the  or  button to display **MV:NO** or **MV:NC**.

7. Repeat step 5 and 6 for each flow sensor module installed. The flow meter icon  indicates the module being addressed.
8. Press the  button to display **NF -- --** (Nominal Flow). This is the measured flow rate when no stations are operating. This setting triggers an alarm when flow ranging from 1 to 99 PPS (pulses per second) is detected while the controller is idle.
9. Press the  or  button to select 01 through 99. Selecting -- -- deactivates this feature.
10. Press the  button to display **CLR:LF** (Clear Learned Flow).
  - To retain the current Learned Flow value, press the  button.
  - To clear the current Learned Flow value, press the  button to display **OK?**. Press the  button again. Continue when **DONE** is displayed.
11. Press the  button to display the flow sensing option. **FLO – N** (Flow sensing - No) is selected by default.
12. To bypass flow sensing for the displayed station number, press the  button. The next station in sequence will be selected.
 

**To enable flow sensing** for the displayed station number, press the  or  button to display **FLO-Y** (flow sensing- yes). The flow meter icon  indicates the currently assigned sensor module. To select a different Flow Sensor Module (if installed), press the  or  button to reposition the icon to the preferred module. Set additional operating parameters for this station by continuing at step 13.
13. Press the  button to select **OF -- --**. This setting selects an Over-flow boundary by %.
14. Press the  or  buttons to select a value from -- -- (none) to 100% in 10% increments.
15. Press the  button to select **UF -- --**. This setting selects an Under-flow boundary by %.
16. Press the  or  buttons to select a value from -- -- (none) to 100% in 10% increments.
17. Press the  button to select **CF -- --**. This is the Critical-flow boundary by %. If the detected flow rate reaches this limit, the station(s) and master valve assigned to this flow sensor will be shut off **immediately** and an alarm will be triggered. The next station(s) in sequence will start.
18. Press the  or  buttons to select the Critical-flow boundary % value from -- -- (none) to 100% in 10% increments.
19. Press the  button to select **LF -- --**. This setting is for Learned flow. Displayed in Pulses Per Second (PPS), the Learned flow rate will be entered automatically as each station (assigned to flow monitoring) is operated. No user action is required here.
20. Press the  button. Repeat steps 12–20 for each station as needed.

## Rain Sensor Timed Bypass



Rain sensor operation is manually controlled by the bypass switch (see item 14 on page 4). The TMC-424 has a unique feature called “Timed Bypass” that bypasses any rain sensor input and overrides the rain sensor switch regardless of its set position. At midnight the Timed Bypass override is automatically released. By default, Timed Bypass is not active. To activate this feature, use the following procedure.

1. Turn the Function Dial to the **Sensors**  dial position. **TBP - N** (Timed Bypass – No) is displayed.
2. Press the  or  buttons to select **TBP-Y** (Timed Bypass – Yes).

## Water Budget Function

The water budget feature enables the run time of all stations assigned to a specified program to be increased by percentage from the 100% baseline to 200% or decreased to 0% (Off) in 10% increments.

**Note:** The Water Budget feature modifies controller operation only and does not alter the controller’s programmable memory. All station times are retained in the controller’s programmable memory and returned to their set value when the Water Budget value is reset to 100%. The adjusted station run time will be displayed during operation. The % symbol will be displayed when Water Budget is set.

1. Turn the Function Dial to the **Water Budget**  position.
2. Press the  button to increase or  button to decrease the % value.

**Note:** A water budget % adjustment will remain in affect until either changed or the program memory is erased.







3. Turn the Function Dial to the **RUN**  position.

## Valve Test Function

This feature allows you to quickly step through the operation of each station for initial installation check, periodic maintenance, spring start-up etc.

The preset time for each station is two minutes but can be quickly adjusted from 30 seconds to 10 minutes.

**Note:** Only stations with a run time (assigned to any program) will be included in the test operation.

1. Turn the Function Dial to the **Valve Test**  position. All station numbers with an assigned run time in any program will be displayed. The display will show **2 M** (2 minutes) of run time per station.
2. To change the valve test duration, press the  or  buttons to select a run time from 30 seconds to 10 minutes.
3. Press the  button. The first station in sequence will turn on. The operating station number and Water On  icon will begin flashing.
4. Turn the Function Dial to the **RUN**  position. The stations will operate one at a time in numeric sequence. The automatic mode will resume when the valve test operation is finished.

**Note:** To turn off an active station and start the next station in sequence, press the  button. Review operation will be terminated when the last station number displayed has completed its run time or has been skipped.



**To terminate operation**, turn the Function Dial to **OFF** . Wait for display to stop flashing, then turn the dial to the **RUN**  position.

## Program Review Function

The Program Review feature provides a convenient method of reviewing all user-defined programming information.

Program elements will be displayed as follows:





- Cumulative run time of all assigned stations (adjusted for Water Budget and Well Recovery delay time).
- Station run times in each module bay.
- Program start times
- All flow settings (when flow sensing option is used).

1. Turn the Function Dial to the **Review**  position.
2. Set the Program Switch to select the program to be reviewed.
3. Press the  button to index through the program information.
4. When finished, turn the Function Dial to the **RUN**  position.



## Rain Delay Function

**Note:** The Rain Delay and Water Budget control features enable quick, temporary changes in operation to help compensate for changes in weather and season.

Rain Delay enables all automatic watering operations to be delayed from 1 to 14 days. For example, rain is forecast in your area for the next two days. Instead of turning the controller off and possibly forgetting to turn it back on, a 3-day delay can be easily set. At the end of 3 days, the controller will resume automatic operation as scheduled.

1. Turn the Function Dial to the **OFF**  position.
2. Press the  or  buttons to select the number of days to delay operation from 1 to 14.
3. Turn the Function Dial to the **RUN**  position.

**Note:** OFF and the number of rain delay days remaining until automatic operation resumes will be displayed (alternating with the current time). The rain delay day number will decrease by one at each day change. Automatic operation will resume when the watering delay day number is no longer displayed.

4. To terminate the rain delay function, turn the Function Dial to the **OFF**  position.
5. Press the  button until only OFF is displayed.
6. Turn the Function Dial to the **RUN**  position.

## Installation Procedure

### Preparing the Cabinet for Installation

1. Swing open the timing mechanism to access the internal components and wiring access holes.
2. Five wiring access holes are provided in the bottom of the cabinet as follows:
  - A- 1/2" (13mm) for power and equipment ground wires (Outdoor models) or 1/4" (6mm) for transformer cable (Indoor models).
  - B- Two 1/2" (13mm) (plugged) for the optional wiring connections.
  - C- Two 3/4" or 1" (19mm or 26mm) for valve and pump relay wiring.
4. If planning to install the optional Toro components, remove the access plugs as necessary.

**Note:** Conduit and adapters are not provided. Always install conduit as required by all building and electrical codes that apply.

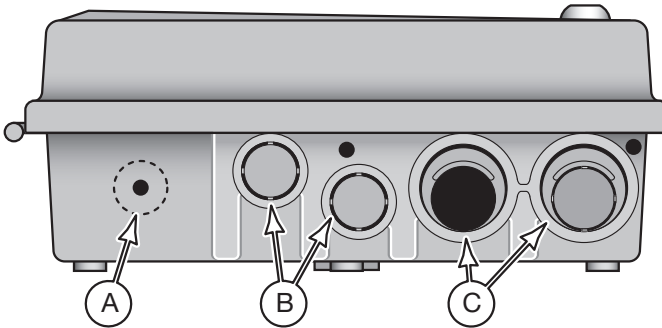

## Cabinet Installation

1. **Indoor Models** – Select a location for the controller within 4' (1.2m) of an electrical outlet to enable the transformer wires to easily reach. Make sure the outlet is not controlled by a light switch or utilized to power a major appliance.

**Outdoor Models** – Select a location which provides the following conditions:

- Protection from irrigation spray and exposure to direct sun during the hottest hours, wind and snow.
- Access to a grounded power source which is not controlled by a light switch or utilized by a major appliance.
- Access to the sprinkler control valve wiring and optional accessory wiring.

2. Drive a wood screw into the wall within eye level until only 1/4" (10mm) of the screw is exposed.

**Note:** If you are installing the controller on drywall or masonry, install appropriate type screw anchors.

3. Hang the cabinet on the screw using the keyhole slot.

4. Open the controller cabinet and swing open the timing mechanism to access the lower mounting screw location.

5. Install the lower mounting screw in the hole provided and tighten securely.

6. Fill out the provided Watering Schedule form with program and system details. Affix the provided velcro disks to the form in the designated locations. Attach the form to the inside of the cabinet cover.

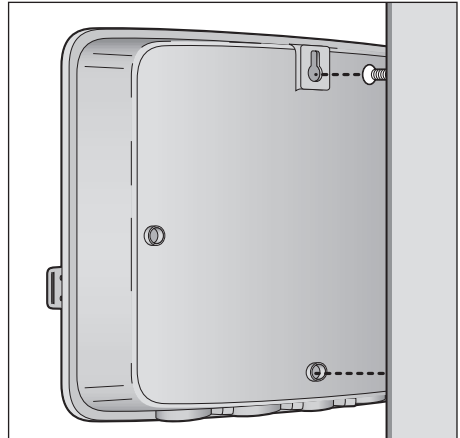

## Valve Connections

**Note:** Using 14 to 18 AWG solid copper irrigation cable is recommended. This cable is made specifically for automatic irrigation systems and is available in several lengths and conductor count. Always use a cable that has at least one wire for each valve and one wire for the valve common connection.

1. Route the valve control wires between the valves and the controller.
2. Attach the white cable wire to one wire from each valve solenoid. (Either solenoid wire can be used for this connection.) This will be designated as the valve common wire.
3. Attach a separate cable wire to the remaining wire from each valve solenoid. Make a note of the wire color code used for each valve and the watering

station it controls. You will need to have this information available when connecting the valve wires to the controller.

- Secure all wire splices using twist-on wire connectors. To prevent corrosion and possible short circuits, use a grease cap or similar waterproofing method to insulate each connection.
- Route the wire cable into the controller through the opened 3/4" (19mm) access hole in the base of the housing or through the PVC conduit if it is installed. Strip insulation back 1/2" (13mm) from all cable wires.
- Secure the valve common wire to the PCB terminal labeled C (common). Connect the individual station valve wires to the appropriate station module terminals.
- Connect one wire from the master valve or pump start relay to the PCB terminal labeled PUMP/MV.

**⚠ CAUTION: Never connect an auxiliary pump starter directly to the controller. A 24V, 0.5A (max) relay must be used to connect the controller to the pump starter circuit.**

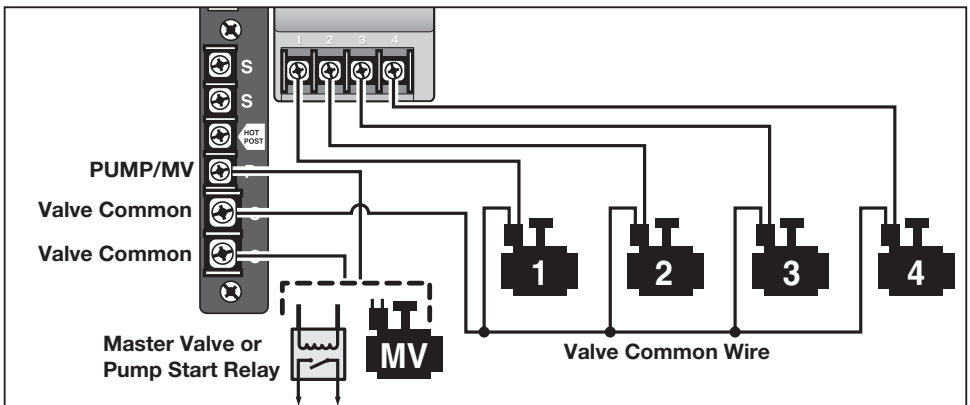

### Flow Sensor Connection

- Route the flow sensor wires into the controller cabinet.
- Connect the sensor wires to the control module terminal block as follows: Black to negative (-) and Red to positive (+).

**Note:** Sensor wires must be installed in the correct polarity to enable operation.

(continued)

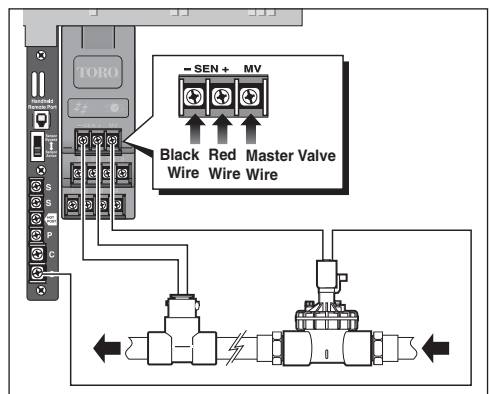

- If the master valve circuit is used, connect either valve wire to the MV terminal and the remaining wire to either common (C) terminal.

**Note:** During operation, the the control module's master valve is active only when a station assigned to the master valve is operating.

## Power Connection - Indoor Models

### North American Models

- Route the transformer cable through the small opening provided in the base of the controller cabinet.
- Place a knot at approximately 12" (30.5cm) from the end of the cable to serve as the cable restraint.
- Connect the red wire to 24V, black wire to COM and the green wire to ground  $\perp$ .

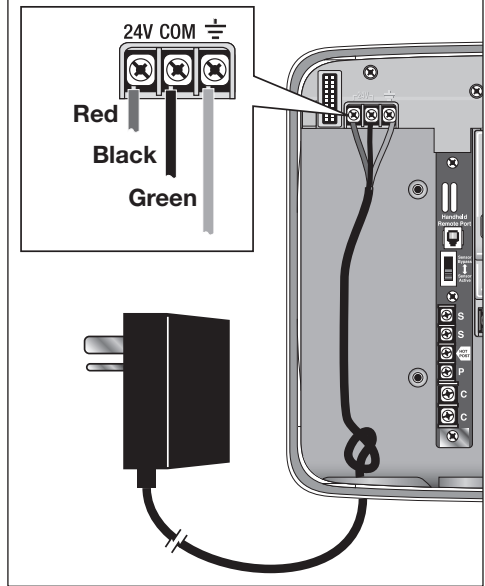

### European Models

**Note:** A Class C power cord and strain relief are supplied with the European indoor controller models. The power cord installs to an internal terminal block as illustrated below.

- Remove the transformer compartment cover secured by two phillips screws.
- Referring to the illustration, install the power cord strain relief and tighten securely using appropriate hand tools.
- Carefully remove 26mm (1") of outer cord sheathing to increase wire exposure.
- Insert the power cord through the strain relief and into the cabinet.
- Connect power cord wires to the terminal block as follows:  
brown wire to L, blue wire to N and green wire to ground  $\perp$ .
- Tighten the bottom strain relief nut using an appropriate hand tool. Pull on cord lightly to confirm security.

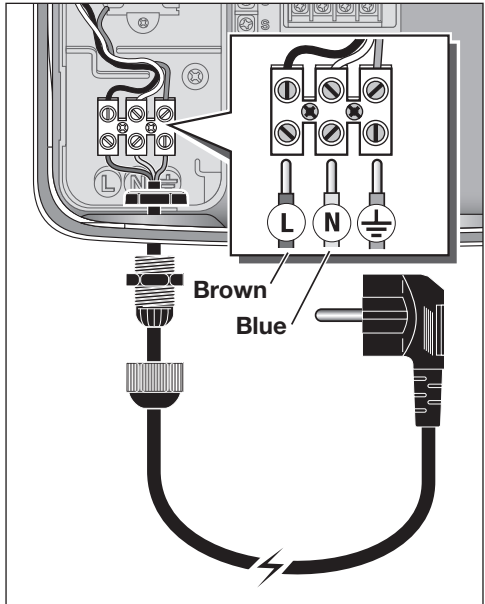

## AC Power Connection - Outdoor Models

**⚠ WARNING:** AC power wiring must be installed and connected by qualified personnel only. All electrical components and installation procedures must comply with all applicable local and national electrical codes. Some codes may require a means of disconnection from the AC power source installed in the fixed wiring and having a contact separation of at least 0.120" (3mm) in the line and neutral poles. Make sure the power source is OFF prior to connecting the controller.

1. Remove the transformer compartment cover secured by two phillips screws.
2. Install 1/2" (13mm) conduit from the power supply to the controller.
3. Route the AC power and equipment ground wires from the power source, through the conduit and into the transformer compartment.

**Note:** The controller terminal block accepts wire size up to 12 AWG.

4. Secure the wires to the terminal block as follows: Hot or Line 1 to **L**, Neutral or Line 2 to **N** and equipment ground to  $\oplus$ .
5. Reinstall the transformer compartment cover and apply power to the controller.

**Note:** In lightning-prone regions, in addition to using station output modules with high level surge protection, installing a ground lug (not provided) to facilitate an earth ground connection may be recommended. Refer to the inset detail shown below for suggested installation method. Contact an authorized Toro representative for specific grounding recommendations in your region.

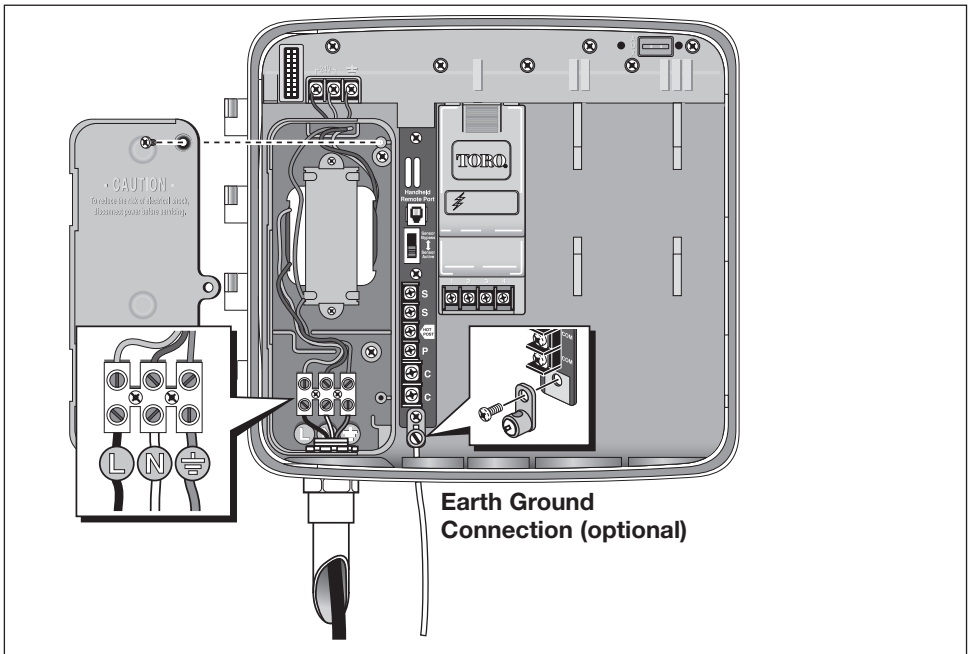

## Toro Wireless Rain and Rain/Freeze Sensor Installation

The Toro Wireless Rain and Rain/Freeze Sensors are available to connect directly to the TMC-424 to automatically interrupt automatic controller operation during rain and/or freeze conditions.

When the sensor absorbs moisture or detects a near-freezing temperature, it signals the TMC-424 to suspend automatic watering operations. SEN will be displayed until the sensor automatically resets enabling the controller to return to automatic operation.

**Note:** A sensor bypass switch is provided to disable sensor operation as needed.

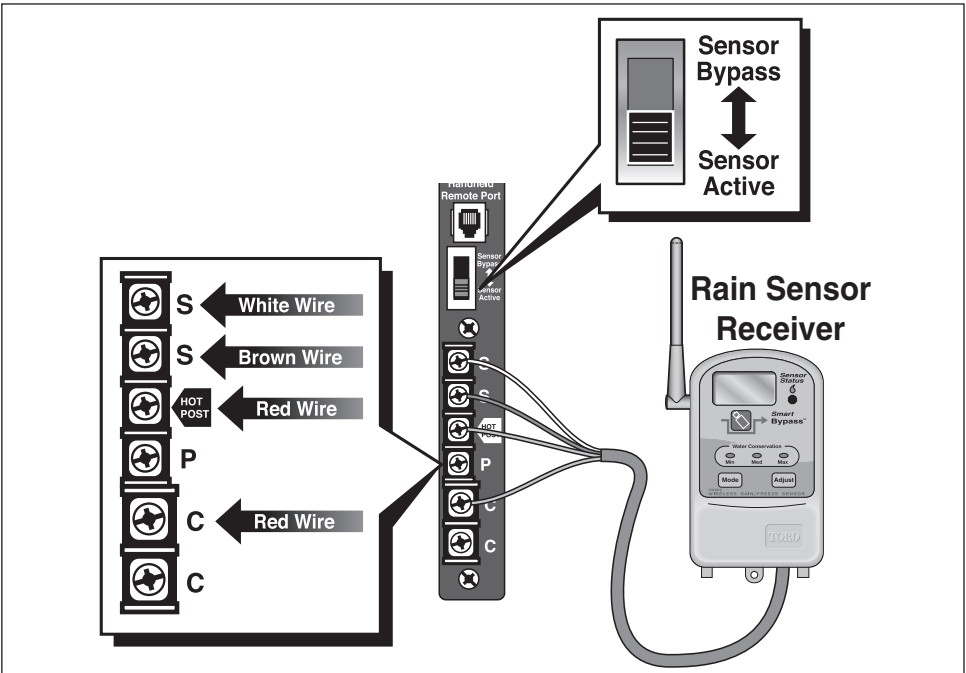

1. Route the sensor wires from the device into the controller housing through the provided access hole.
2. Remove the jumper wire installed between the sensor terminals.
3. Connect the white wire to the top sensor (S) terminal. Connect the brown wire to the remaining sensor (S) terminal. Connect the two red wires to the Hot Post and one common (COM) terminal.
4. Set the sensor switch to Sensor Active.
5. Refer to the instructions provided with the Toro Wireless Rain Sensor additional installation and set up information.

## Appendix

**Table 1**  
**Data Industrial 228/250 Series Flow Sensor Data**

Model	K Value	Offset	Flow Rate
250BR0700x-xxxx	0.436827	0.567915	5-100 GPM
250BR1000x-xxxx	0.397368	0.261768	5-100 GPM
228PV15xx-xxx	1.699	-0.316	5-100 GPM
228PV20xx-xxx	2.8429	0.1435	10-200 GPM
228PV30xx-xxx	8.309	0.227	20-300 GPM
228PV40xx-xxx	13.74283	0.23707	40-500 GPM

### Converting PPS to GPM/LPM

The flow meter measures water flow in PPS (Pulses per Second). To convert PPS to GPM (Gallons per Minute) or LPM (Liters per Minute), use the following formula:

#### To convert PPS to GPM:

$$K \times (F + \text{Offset}) = \text{GPM}$$

Where: K = K value of meter

F = Flow rate in PPS

Offset = Offset value of meter

Example (flow meter 228PV15xx-xxx is installed):

$$K = 1.699$$

$$F = 40 \text{ PPS}$$

$$\text{Offset} = -0.316$$

$$1.699 \times (40 - 0.316) = 67 \text{ GPM}$$

#### To convert GPM to LPM:

$$\text{GPM} \times 3.7854 = \text{LPM}$$

$$67 \times 3.7854 = 254 \text{ LPM}$$

## Determining Maximum Current Load

**Table 2** above provides various current load combinations that are possible when using 1, 2 or 3 watering programs running simultaneously with master valve/pump start control options.

	Acceptable									Marginal		Exceeds Limit					
<b>Station Valves</b>	1	1	1	2	1	1	2	2	3	2	3	2	3	3	3	3	3
<b>Master Valves</b>	0	0	1	0	2	1	1	0	0	1	1	2	0	1	2	2	3
<b>Pump Start</b>	0	1	0	0	0	1	0	1	0	1	0	1	1	1	0	1	0
<b>Total Current</b>	0.3	0.6	0.6	0.6	0.9	0.9	0.9	0.9	0.9	1.2	1.2	1.5	1.5	1.5	1.5	1.6	1.8

The values in the Station Valve row indicate the number of solenoid loads based on one station/valve per program. The Master Valve and Pump Start row values are based on one load per circuit and one or two Flow Modules each utilizing the individual Master Valve control output.

**Note:** The maximum total current load permitted is 1.20A @24 VAC. The valve and relay loads shown in the chart are based on 0.30A @ 24 VAC (nominal). Actual current draw will vary with make, model, configuration and size of valves and relays in use. Check the manufacturer’s specifications and recalculate the maximum number of loads permitted based on actual values.

## Troubleshooting

### Fuse – Electronic Circuit Breaker

The TMC-424 features built-in circuit protection to help prevent damage to the controller caused by excessive current draw on the station and/or pump/master valve circuits.

If the controller detects an overload condition, it will bypass the affected station(s). The remaining stations will operate as programmed for automatic operation. After watering ends, **FUSE** will be displayed with the affected station number(s).

If the condition occurs on the Pump Start/Master Valve circuit, all stations using the master valve will show **FUSE**.

To clear the warning display, press **any** button. The controller will continue to operate as scheduled and will attempt to run all stations as programmed.

**⚠ IMPORTANT:** Clearing the display does not correct the problem. The controller will retry the affected station(s) at each programmed watering cycle and bypass the affected station(s) until the problem is corrected.

Before continuing to operate the controller, identify and correct the source of the problem. In most cases, the FUSE alert condition is caused by a faulty valve solenoid, pump start relay and/or shorted wire splice.

### Flow Alarm

When using the TMC-424 with flow monitoring, exceeding the Under-flow, Over-flow, Nominal (no) flow and Critical flow boundaries will signal an alert warning. After watering ends, the display will show FLOW (FLOW 0 for no-flow conditions). with the affected station number(s). To clear the warning display, press **any** button. The controller will continue to operate as scheduled and will attempt to run as programmed.

See IMPORTANT information above.

## Specifications

### **Cabinet Dimensions:**

10.5" W x 9.5" H x 5" D

### **Temperature Limit Range:**

Operating: +14°F to +140°F (-10°C to +60°C)

Storage: -22°F to +149°F (-30°C to +65°C)

### **Power Specifications:**

Indoor Model - North America

Plug-in Transformer, Class 2, UL Listed, CSA-certified

- Input: 120 VAC  $\pm$  10%, 50/60 Hz
- Output: 24 VAC  $\pm$  10%, 50/60 Hz, 30 VA

Indoor Model - Europe

Built-in Transformer with Class C power cord, TUV Approved

- Input: 230 VAC  $\pm$  10%, 50/60 Hz
- Output: 24 VAC  $\pm$  10%, 50/60 Hz, 30 VA

Indoor Model - Australia

Plug-in Transformer, SAA Approved

- Input: 240 VAC  $\pm$  10%, 50Hz
- Output: 24 VAC  $\pm$  10%, 50 Hz, 30 VA

Outdoor Model - North America

Built-in Transformer, Class 2, UL Listed, CSA Certified (or equivalent)

- Input: 120 VAC  $\pm$  10%, 50/60 Hz

Outdoor Model - Europe

Built-in Transformer, TUV Approved, SAA Approved

- Input: 230 VAC  $\pm$  10%, 50/60 Hz
- Output: 24 VAC  $\pm$  10%, 50/60 Hz, 30 VA

Outdoor Model - Australia

Built-in Transformer, SAA Approved

- Input: 240 VAC  $\pm$  10%, 50/60 Hz
- Output: 24 VAC  $\pm$  10%, 50/60 Hz, 30 VA

### **All models:**

#### **Maximum Load Per Station:**

0.5A @ 24 VAC

#### **Maximum Load Per Pump/Master Valve Circuit:**

0.5A @ 24 VAC

**Total Maximum Output:** 1.20A @ 24 VAC

## The Toro Promise — Limited Five-year Warranty

The Toro Company and its affiliate, Toro Warranty Company, pursuant to an agreement between them, jointly warrants, to the owner, each new piece of equipment (featured in the current catalog at date of installation) against defects in material and workmanship for a period described below, provided they are used for irrigation purposes under manufacturer's recommended specifications. Product failures due to acts of God (i.e., lightning, flooding, etc.) are not covered by this warranty.

Neither Toro nor Toro Warranty Company is liable for failure of products not manufactured by them even though such products may be sold or used in conjunction with Toro products.

During such warranty period, we will repair or replace, at our option, any part found to be defective. Your remedy is limited solely to the replacement or repair of defective parts.

Return the defective part to your local Toro distributor, who may be listed in your telephone directory Yellow Pages under "Irrigation Supplies" or "Sprinkler Systems," or contact The Toro Warranty Company P.O. Box 489, Riverside, California, 92502. Phone (800) 664-4740 for the location of your nearest Toro distributor or outside the U.S., call (951) 688-9221.

This warranty does not apply where equipment is used, or installation is performed in any manner contrary to Toro's specifications and instructions, nor where equipment is altered or modified.

Neither Toro nor Toro Warranty Company is liable for indirect, incidental or consequential damages in connection with the use of equipment, including but not limited to: vegetation loss, the cost of substitute equipment or services required during periods of malfunction or resulting non-use, property damage or personal injury resulting from installer's actions, whether negligent or otherwise.

Some states do not allow the exclusion or limitation of incidental or consequential damages, so the above limitation or exclusion may not apply to you.

All implied warranties, including those of merchantability and fitness for use, are limited to the duration of this express warranty.

Some states do not allow limitations of how long an implied warranty lasts, so the above limitation may not apply to you.

This warranty gives you specific legal rights and you may have other rights which vary from state to state.

The Toro TMC-424 series controllers are covered by this warranty for a period of five years from the date of installation.

## FCC Compliance Information

This equipment generates and uses radio frequency energy and if not installed and used properly, that is, in strict accordance with the manufacturer's instructions, may cause interference to radio and television reception. It has been type tested and found to comply with the limits for a FCC Class B computing device in accordance with the specifications in Subpart J of Part 15 of FCC Rules, which are designed to provide reasonable protection against such interference in a residential installation. However, there is no guarantee that interference will not occur in a particular installation. If this equipment does cause interference to radio or television reception, which can be determined by turning the equipment off and on, the user is encouraged to try to correct the interference by one or more of the following measures:

- Reorient the receiving antenna.
- Relocate the irrigation controller with respect to the receiver.
- Move the irrigation controller away from the receiver.
- Plug the irrigation controller into a different outlet so that the irrigation controller and receiver are on different branch circuits.

If necessary, the user should consult the dealer or an experienced radio/television technician for additional suggestions. The user may find the following booklet prepared by the Federal Communications Commission helpful:

"How to Identify and Resolve Radio/TV Interference Problems." This booklet is available from the U.S. Government Printing Office, Washington, DC 20402.

Stock No. 004-000-00345-4